

# EcoFlow STREAM Microinverter

Thank you for choosing our product!

## Contents

### About This Manual

#### Overview

Appearance

LED Indicator

Dimensions

#### Get Started

Understand the EcoFlow STREAM Plug & Play Solar System

Install the Microinverter

Connect the Microinverter

Activate the Microinverter

#### Smart Control

EcoFlow App

Register and Log In

Bind the Device and Set Up the Internet

Access Device Management

Key Functions

#### Explore More

Add EcoFlow STREAM AC Pro for Energy Storage

Add EcoFlow STREAM Ultra/Pro for Energy Storage and Extra Solar Input

#### Storage and Maintenance

Routine Maintenance

Product Removal

Long-term Storage

Troubleshooting

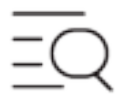

FAQ



EcoFlow App



After-sales  
Policy



Community

## About This Manual

- This manual contains an introduction to this product, and details on its operation, management, and maintenance. Please note that this manual may be updated without prior notice.
- The availability of certain accessories and features described in this manual may vary depending on your country or region.
- All images displayed in this manual are for demonstrative purposes only. Refer to the actual product received.
- If you are reading this manual in PDF format, please note that you can access it online at [EcoFlow Support](#) for a better experience and the latest updates.

## Overview

EcoFlow STREAM microinverter (hereinafter referred to as "the microinverter" or "this product") supports dual solar inputs and can be easily connected to your home circuit, making it ideal for residential setups. It converts solar energy into AC power to supply home appliances or feed excess energy into the grid, helping reduce electricity bills.

## Appearance

## Safety Instructions and Regulatory Compliance

Disclaimer

Safety Symbols

Safety Instructions

Regulatory Compliance

## Appendix

Technical Specification

Compatibility List

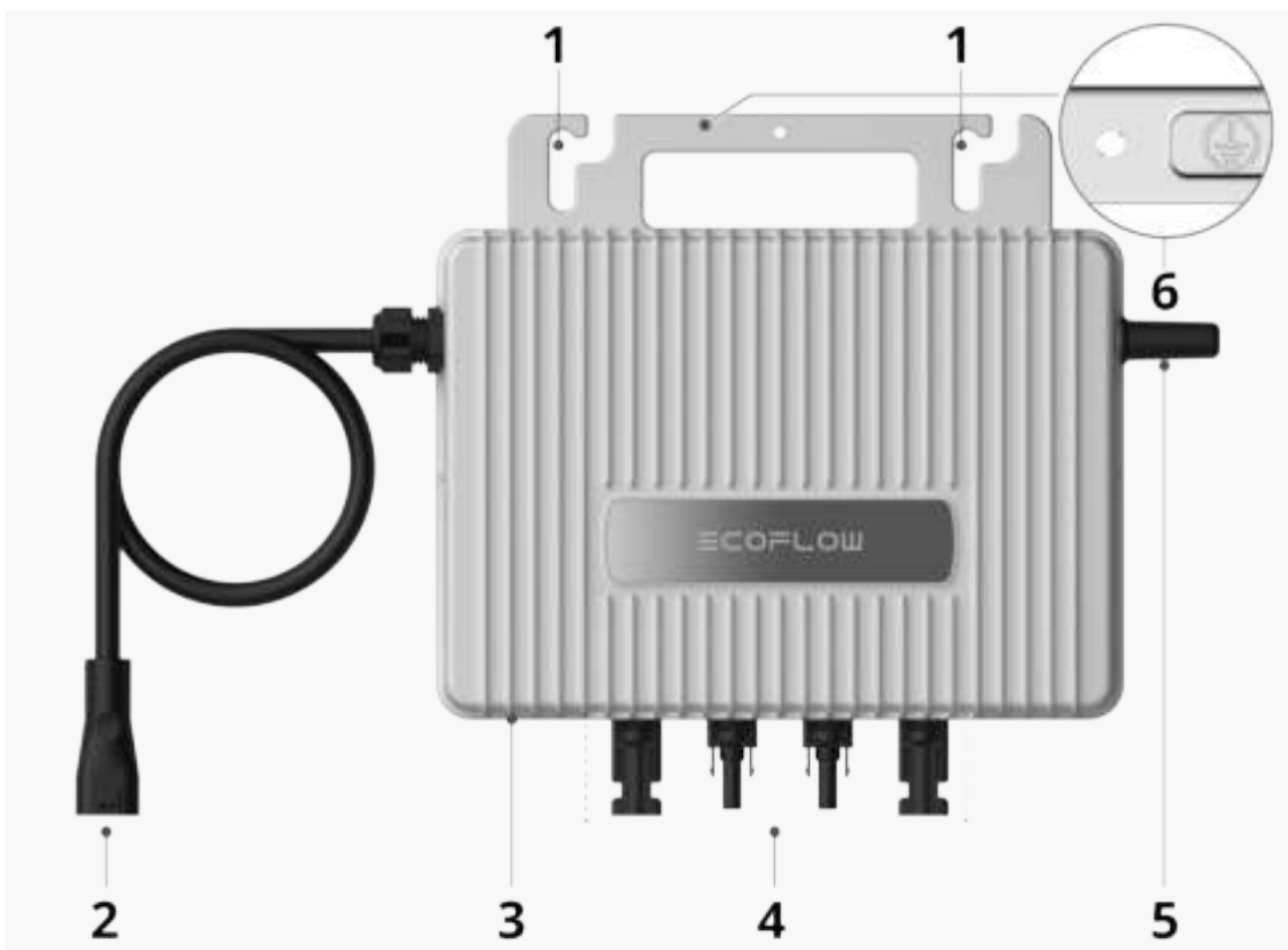

1	Mounting Holes	Used for attaching the microinverter to a solar panel, or mounting on the wall.
2	AC Terminal	Used for connecting the microinverter to a standard AC outlet (EU region) or a home branch circuit breaker (UK region).
3	LED Indicator	Used for displaying the operating status of the microinverter.
4	PV Terminals	Used for connecting the microinverter to solar panels.
5	Antenna	Used for enhancing wireless signal strength.
6	Grounding Terminal (M4 screw)	Used for supplemental grounding connection.

## LED Indicator



Off: The microinverter is powered off.



Flashing Green: The microinverter is starting up, connecting to the wireless network, or updating firmware.



Solid Green: The microinverter is functioning normally, or is in standby mode.



Flashing Red: The microinverter is faulty. Check the EcoFlow app for detailed instructions.



Solid Red: The microinverter is faulty. Open the EcoFlow app to access the device settings. If the app is accessible, follow the in-app troubleshooting steps. If not, contact technical support.

## Dimensions

Refer to the product dimensions to ensure proper installation and space planning.

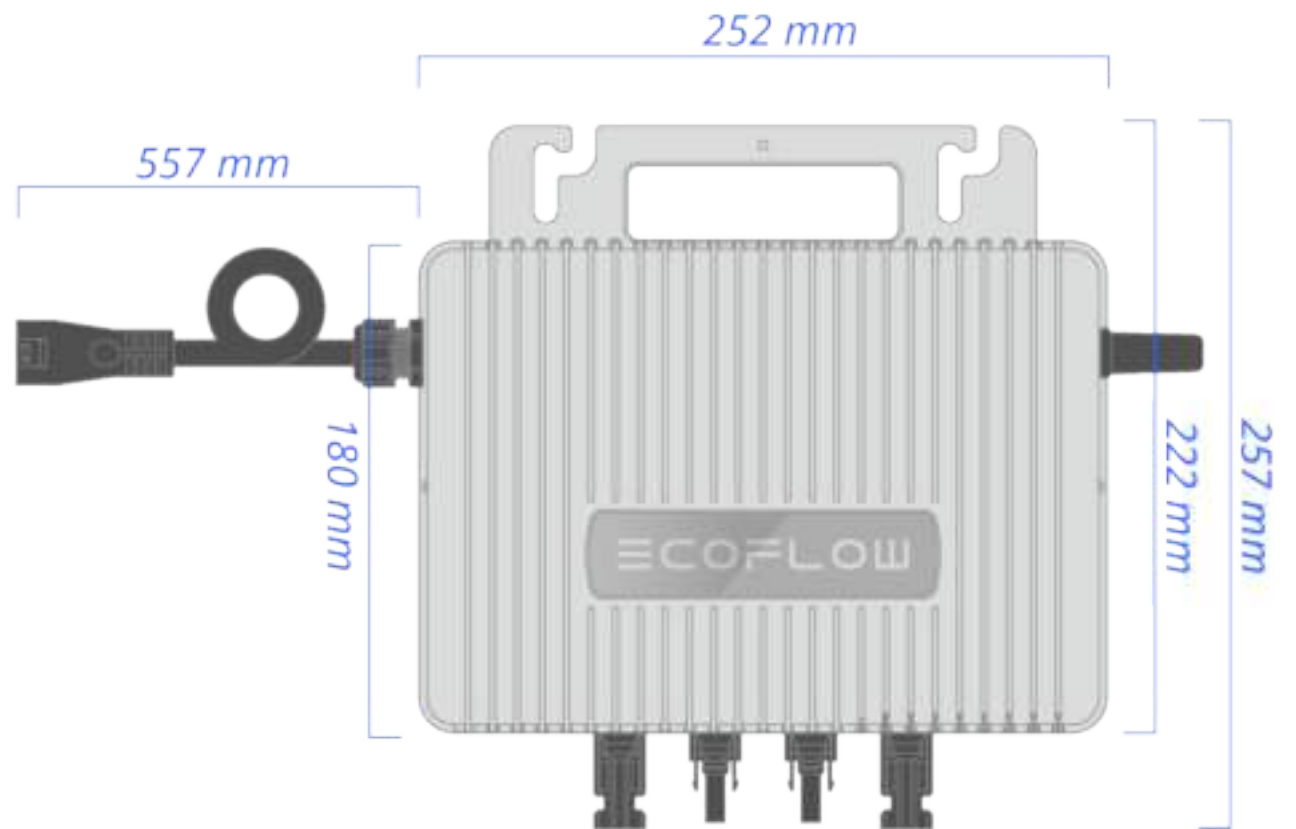

## Get Started

### Understand the EcoFlow STREAM Plug & Play Solar System

This microinverter allows you to utilize solar panels to build an **EcoFlow STREAM Plug & Play Solar System**, which turns your home balcony into a compact self-sufficient power plant. To understand how the system works, let's briefly review its main components:

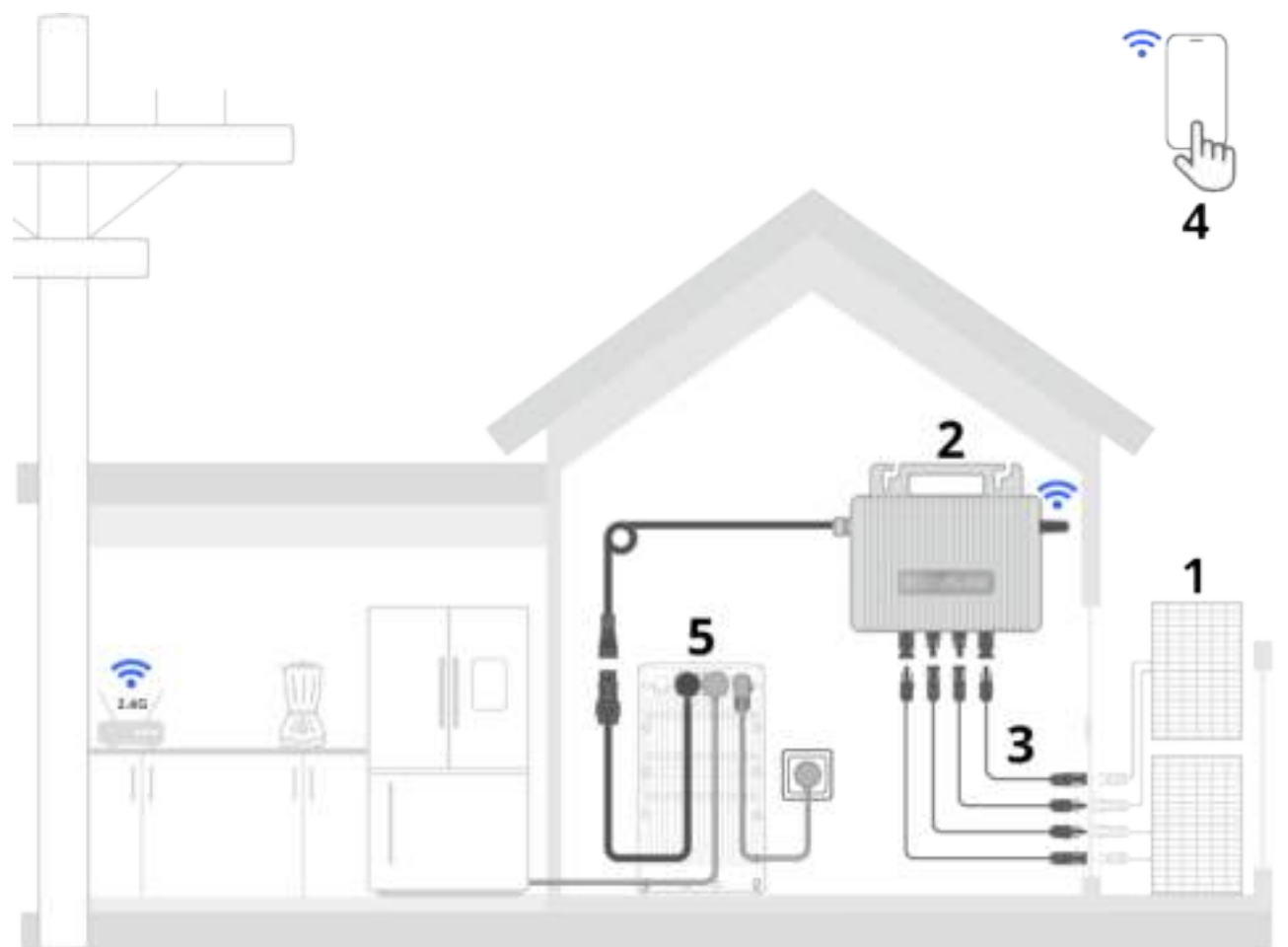

1 Solar Panels

Absorbs sunlight and generates direct current (DC) electricity.

**Tip:** Use EcoFlow solar panels or compatible third-party panels that meet the DC input requirements of the microinverter.

2 EcoFlow STREAM Microinverter

Converts DC power from solar panels into grid-compliant AC power.

3 Connection Cables

Connect solar panels to the microinverter and link the system to the grid via your home outlet or a circuit breaker.

**Tip:** EcoFlow official connection cables are preferred. Third-party cables may require additional steps for proper setup.

4 EcoFlow App

Enables control and monitoring of the PV system via your phone.

5 Optional: EcoFlow STREAM AC Pro / EcoFlow STREAM Ultra / EcoFlow STREAM Pro

Stores the excess power generated by the system and discharges it to support your home power supply during power outages or low solar efficiency.

By setting up this system, the microinverter will optimize solar power to meet the energy needs of your home appliances. Any excess power will be fed back into the grid, helping to reduce your electricity bill.



Electrical codes may vary by region. Before setting up a balcony solar system, check your local regulations and consult a qualified electrician to ensure everything is done safely and in compliance with the applicable laws.

## Install the Microinverter

The microinverter should be installed on a stable surface and positioned ideally for power cable routing and optimal Wi-Fi signal reception. EcoFlow offers two mounting options: wall mounting or attachment to a solar panel. Detailed installation instructions are included in the product packaging and can be found at <https://www.ecoflow.com/support/download/stream-microinverter>.

- Option 1

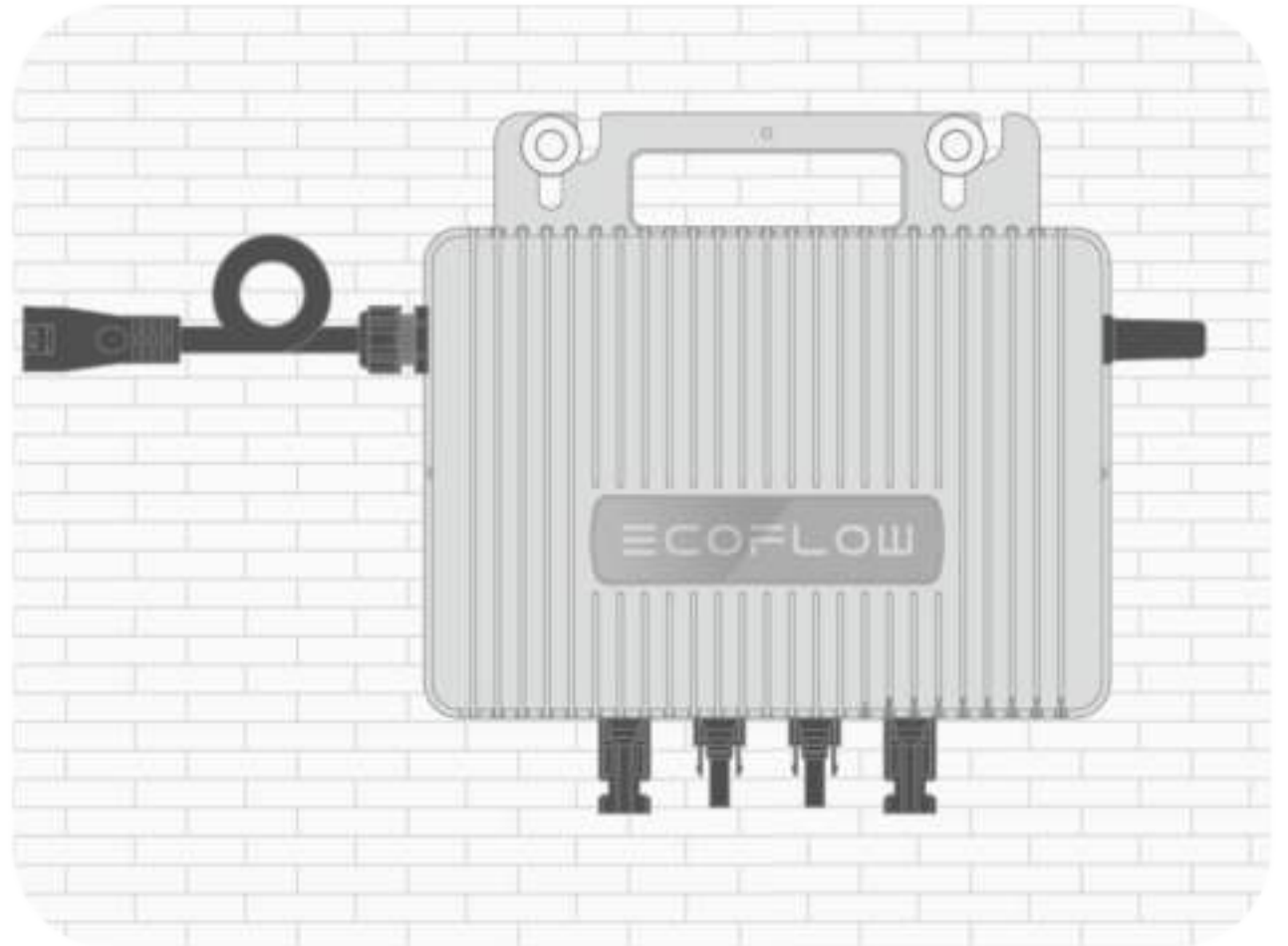

**Recommended Accessory**



- For wall mounting: Expansion screws with pipes (P6×35mm, included in the delivery)

- Option 2

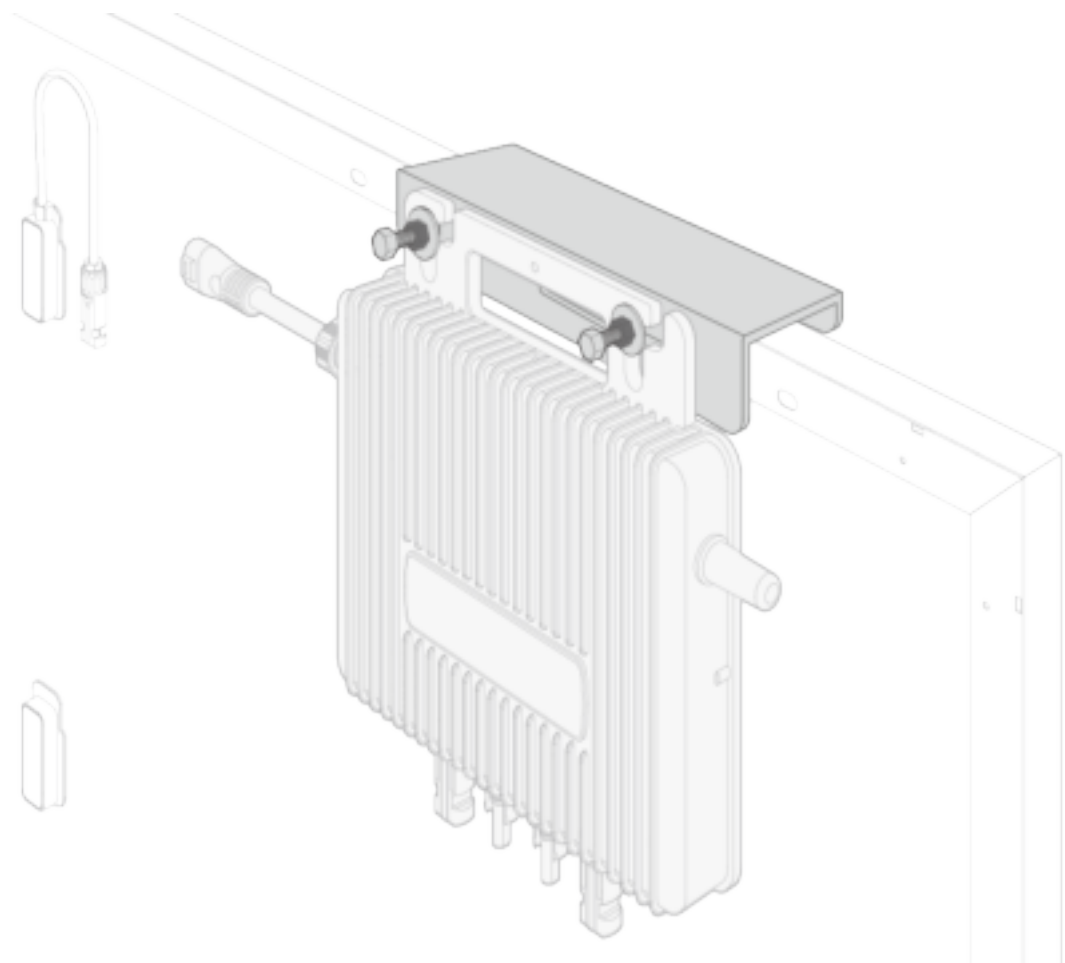



### Recommended Accessory

- For solar panel attachment: EcoFlow PV Clamp

## Connect the Microinverter

After securely mounting the microinverter, connect the necessary power cables (both AC and DC sides).

### Application 1: Home Outlet Connection (For the European Region)

1. Connect solar panels to the PV terminals on the microinverter using specified EcoFlow PV cables.
2. Connect the microinverter to a standard home outlet using a specified EcoFlow AC cable.

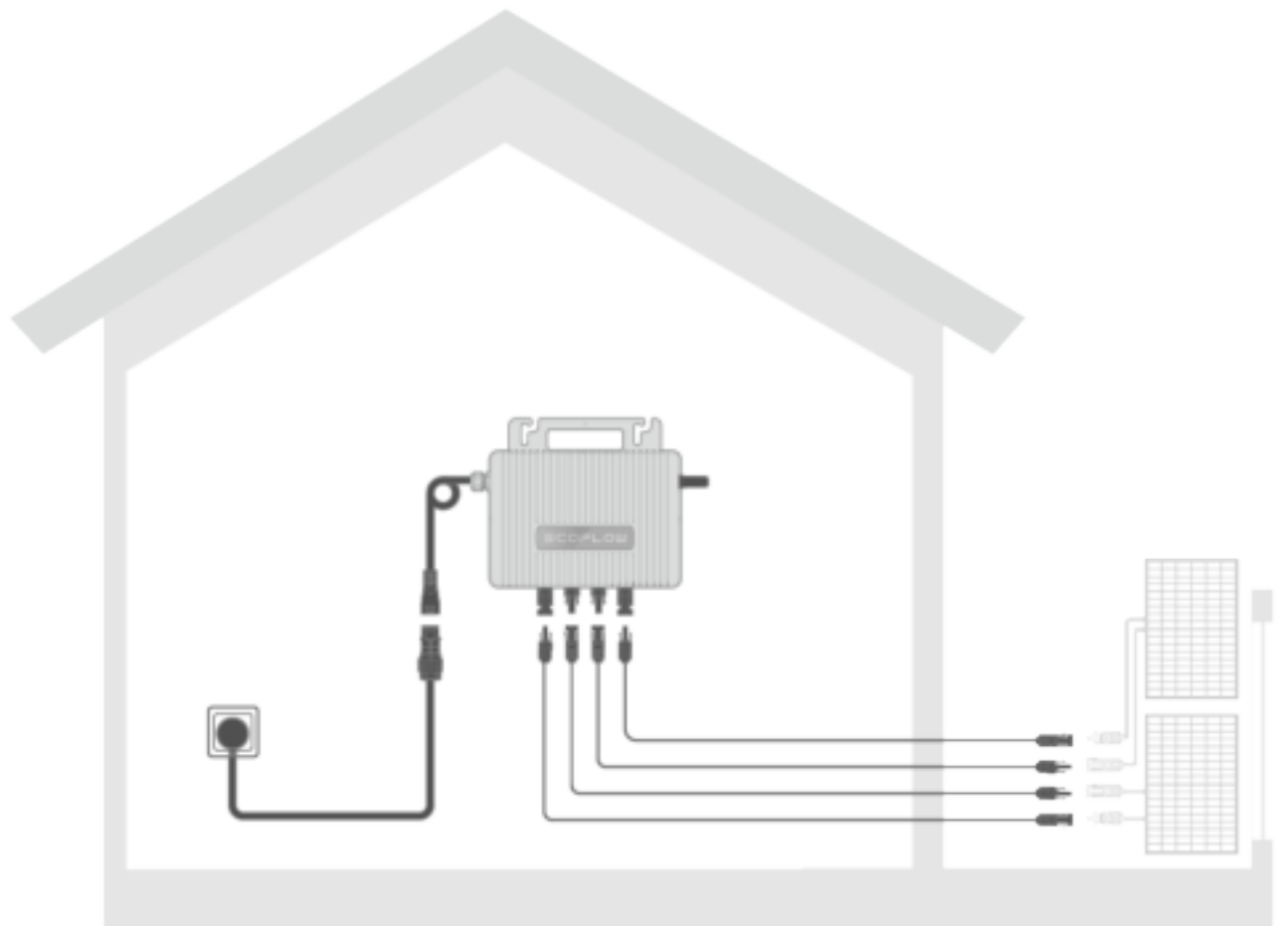

Avoid touching a solar panel's positive (+) and negative (-) wires simultaneously.

1. The appearance of the AC outlet adapts according to your local standards.
2. **Solar Input Specifications per MPPT:**  $V_{max} \leq 60V$ ,  $I_{max} \leq 16A$ .
3. **Solar Input Limit:** For a single input, the maximum is 430W. For dual inputs, the total solar input is subject to local regulations.
4. **Solar Panel Configuration:** The microinverter supports two PV inputs. You can configure solar panels to match the microinverter's input capacity. Furthermore, solar panels connected to the same PV input terminal must have the same electrical specifications.
5. **Recommended Cable:**
  - For PV Connection: EcoFlow STREAM Solar Panel Extension Cable
  - For AC Connection: EcoFlow STREAM BKW-AC Cable



## Application 2: Home Branch Circuit Connection (For the United Kindom Region)

1. Power off the circuit breaker to disconnect the grid power supply.
2. Connect solar panels to the PV terminals on the microinverter using specified EcoFlow PV cables.
3. Connect the microinverter to a branch circuit breaker using a specified EcoFlow AC cable. The PE and Neutral wires should be connected separately to the PE-bar and Neutral-bar, and the Live wire should be connected to the terminal on the breaker that leads to the load side.

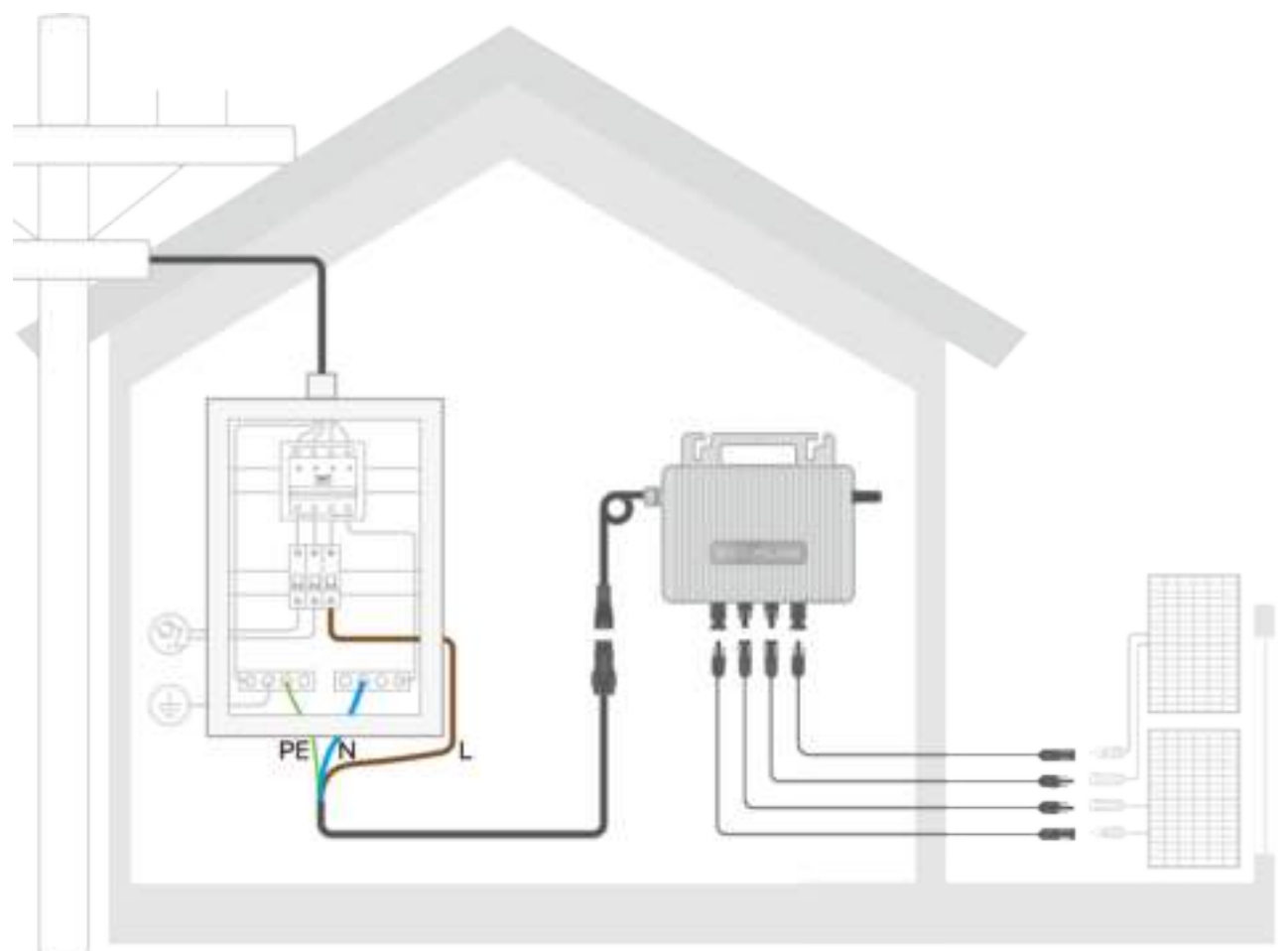

1. **Professional Installation Required:** This installation must be performed by a qualified electrician.
2. **Power Must Be Off:** Before beginning installation, ensure the power is switched off at the installation site.
3.  The microinverter supports two PV inputs. You can configure solar panels to match the microinverter's input capacity. Furthermore, solar panels connected to the same PV input terminal must have the same electrical specifications.
4. Avoid touching a solar panel's positive (+) and negative (-) wires simultaneously.



- 1 **Solar Input Specifications per MPPT:**  $V_{max} \leq 60V$ ,  $I_{max} \leq 16A$ .
2. **Solar Input Limit:** For a single input, the maximum is 430W. For dual inputs, the total solar input is subject to local regulations.
3. **Solar Panel Configuration:** The microinverter supports two PV inputs. You can configure solar panels to match the microinverter's input capacity. Furthermore, solar panels connected to the same PV input terminal must have the same electrical specifications.
4. **Recommended Cable**
  - For PV Connection: EcoFlow STREAM Solar Panel Extension Cable
  - For AC Connection: EcoFlow STREAM BKW DIY Cable

## Grounding Considerations

Proper grounding is essential for safe operation. EcoFlow offers an AC cable with an equipment grounding conductor/a grounding plug. If the cable has been plugged into an outlet that is properly installed and grounded in accordance with all local codes and ordinances, the device will be properly grounded. However, if you encounter the following situations, consult a qualified electrician:

- You are unsure whether the product is properly grounded;
- You find that the plug provided with the product does not fit the outlet.

If the installation site does not meet grounding requirements or specific grounding standards mandated by local codes, ask a qualified electrician to use the grounding terminal on this product to establish proper grounding.



A qualified electrician is always required to carry out grounding work.

## Activate the Microinverter

Once installation is complete, the microinverter starts up automatically. Follow these steps to bind it to your EcoFlow account and complete the initial setup to activate it.

1. Scan the QR code, visit your phone's app store, or go to <https://download.ecoflow.com/app> to download the **EcoFlow** app.

2. Log into your EcoFlow account. If you don't have one, create one first.
3. Tap the "Add Device" button or the "+" icon at the top right corner to search for the microinverter.
4. Select your microinverter and follow the pop-up instructions to complete the device binding and Wi-Fi setup.

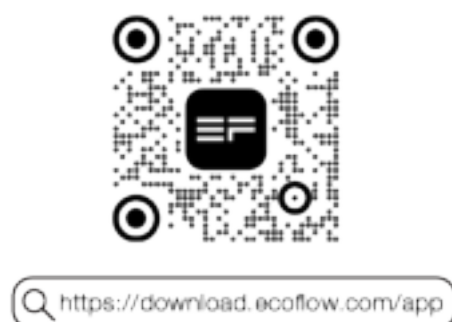

The microinverter may not function properly if it has not been activated through app binding.

## Smart Control

### EcoFlow App

#### App Introduction

EcoFlow offers a companion app for device management. With this mobile application, you can:

- Enjoy all-in-one control of your EcoFlow devices from anywhere.
- Monitor power consumption details seamlessly with real-time updates.
- Personalize your energy scheme with an array of customizable options.
- Promptly receive in-app troubleshooting and firmware updates.

#### App Download Methods

1. Scan the QR code to download.
2. Search for "EcoFlow" in the iOS or Android app store.
3. Visit <https://download.ecoflow.com/app> to download.

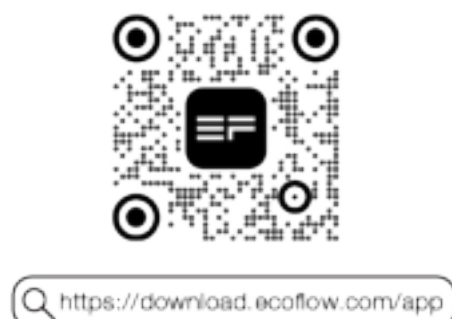



The EcoFlow app continuously adapts to enhance the user experience and functionality. Screenshots in this manual are for demonstration purposes only. The actual appearance may vary depending on the app version and operating system. This manual does not cover every detail of the app's functions, and users are encouraged to explore the app themselves.

## Register and Log In

- **To Register an Account**

1. Open the EcoFlow app and tap "**Create new account**".
2. Enter the required registration information, then tap "**Sign up**". The email address you entered will be used as your EcoFlow account.

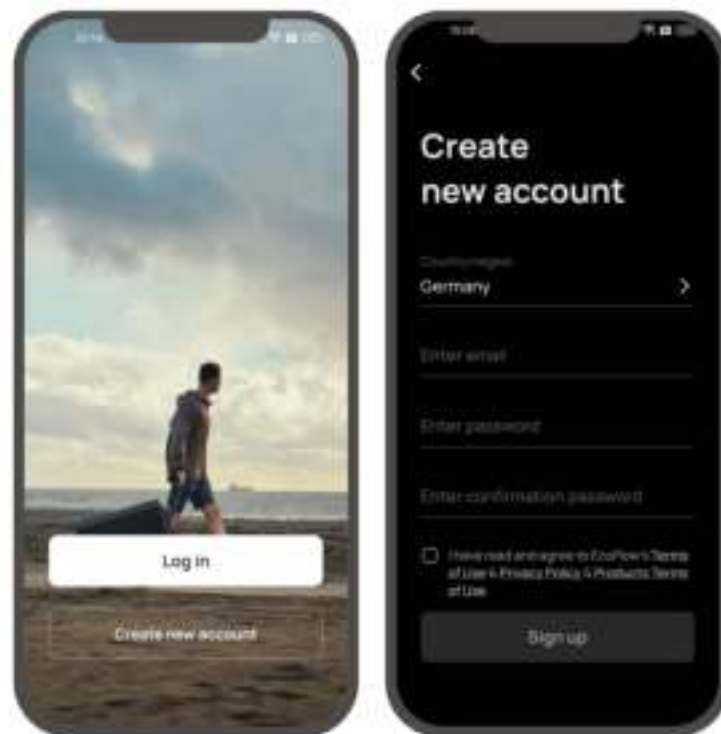

- **To Log In**

1. Open the EcoFlow app and tap "**Log in**".
2. Enter your registered email address and password, and proceed to access the device management page.

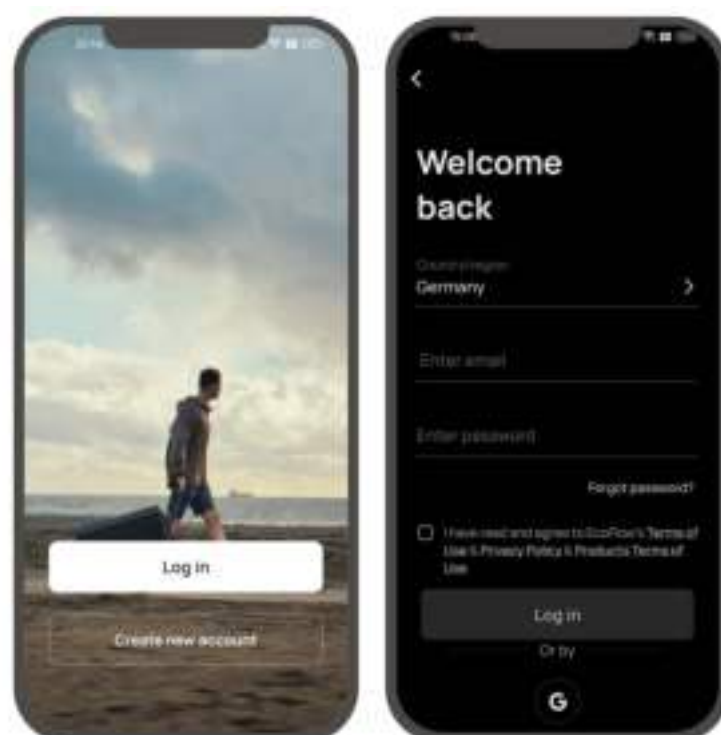

## Bind the Device and Set Up the Internet

When you first set up a new device, bind it to your EcoFlow account to ensure remote access to the device's settings.

- **To bind a new EcoFlow device/system:**

1. Visit the EcoFlow app and log into your EcoFlow account.
2. Tap the "Add Device" button or "+" icon in the top right corner to search for new EcoFlow devices.
3. Select your EcoFlow device and follow the pop-up instructions to complete device binding and Wi-Fi setup.

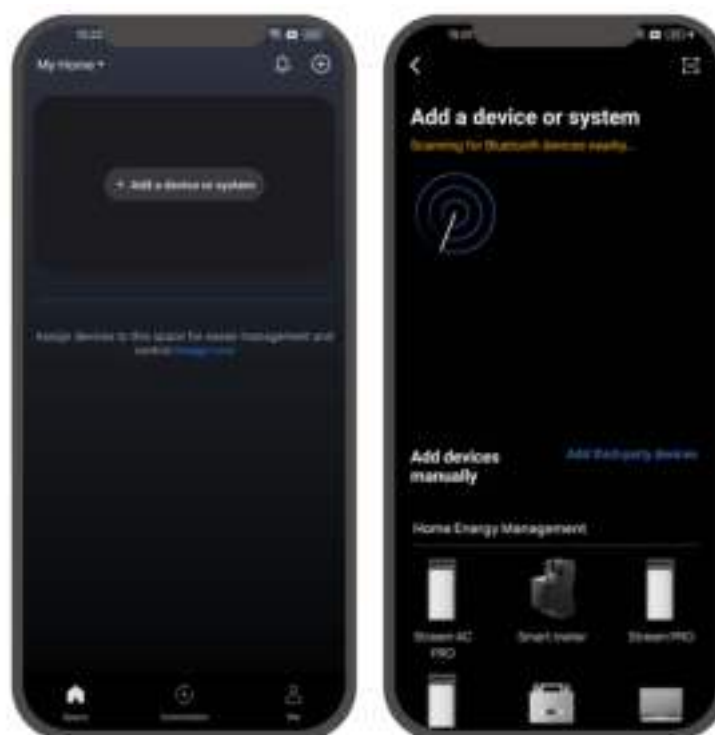

## Access Device Management

With the EcoFlow app, you can manage all your bound devices via phone. The microinverter supports Wi-Fi and Bluetooth connections, adapting to different network conditions to ensure convenient access to device settings.

- **With Internet**

When Wi-Fi is stable, you can access the device settings via the internet. This method is always recommended to ensure your EcoFlow device can receive timely firmware updates and pushes.



- **Without Internet**

If the Wi-Fi connection is unavailable, you can manage the device locally via Bluetooth, though some settings may be restricted.



## Key Functions

### Space

During the device binding process, you can assign the device to a new or existing Space. The Space serves as the homepage that displays the status of all assigned EcoFlow devices. You can customize multiple Spaces based on your device type or usage scenarios.

- **To manage Space**

Tap the space name in the top left corner, then select **Space Management** to add, edit, or delete space.

- **To switch Between Spaces**

Tap the space name to open the dropdown list, then select a space to switch to its homepage view.

- **To view Space status**

Tap the top component to view the total data for the Space page, including details on solar generation, consumption, earnings, and more.



### Device / System

The EcoFlow app supports binding a single device or a specific system to your account at a time. Once assigned to a Space, these devices can be managed.



1. **Current System-Binding Supported Series:** STREAM series, PowerOcean series

*\*Please check the app for updates on the latest supported series.*

2. To bind an EcoFlow system, ensure these devices are connecting to the same wireless network.

- **View Energy Flow**

The energy flow view illustrates the power flow of the current device or system, including both generation and consumption. To switch to another energy flow view, slide to select the device or system name tab.



- **Customize Widgets**

Tap the icon to view the widget component of the current device/system. Each widget displays statistics on energy topics, such as Solar Generation, Total Earnings, and more.

- **To check more details on a topic**  
Tap a widget to view detailed statistics.
- **To customize displayed widgets**  
Tap **Edit** to rearrange the widget layout.



- **Manage Linked Device**

Tap the icon to view the linked device of the current device/system. **Definition of linked devices:** Devices that are part of or compatible with the energy system. Linked devices can be automatically recognized or manually linked during the device binding process.



- **Device Settings / System Settings** Tap the icon to access the settings.
  - **Maximum Output Power:** View or edit the system's maximum power output.
  - **System Name:** Displays or edits the current system name.
  - **Firmware Update:** Check for available firmware updates and install them to ensure your system is up-to-date.
  - **Space:** View or edit the Space to which the system is assigned.
  - **Clear Data:** Tap to clear the data associated with this system.
  - **Delete System:** Delete the system from your EcoFlow account.



## Troubleshooting

The EcoFlow app provides alerts to notify you of potential issues. Each alert appears as a notification message.

Tap an alert message to view details and follow the suggested troubleshooting instructions.

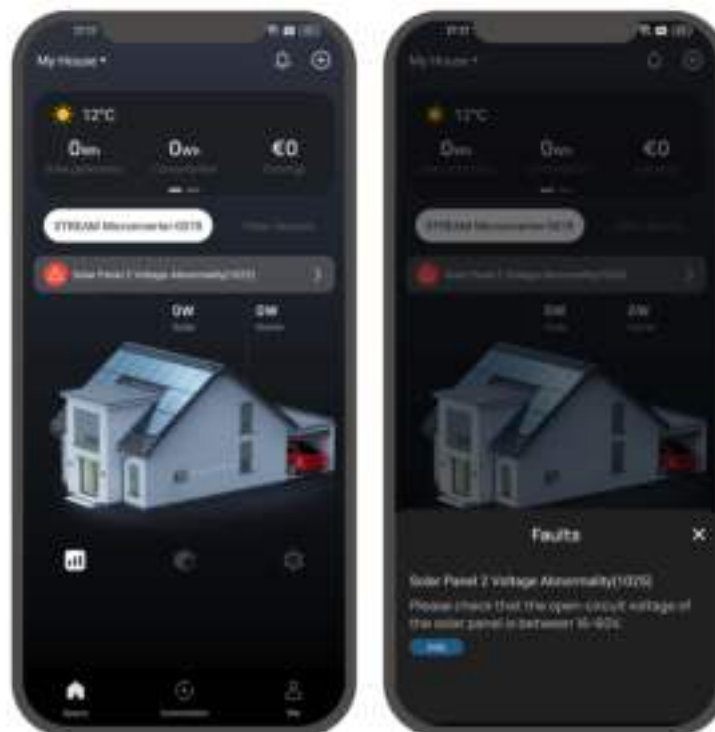

## Firmware Upgrade

1. Tap the gear ⚙ icon to access device settings.
2. Select **Firmware upgrade**.
3. Tap **Update** to start the firmware upgrade process.

Note: Ensure the device has a stable internet connection before updating.

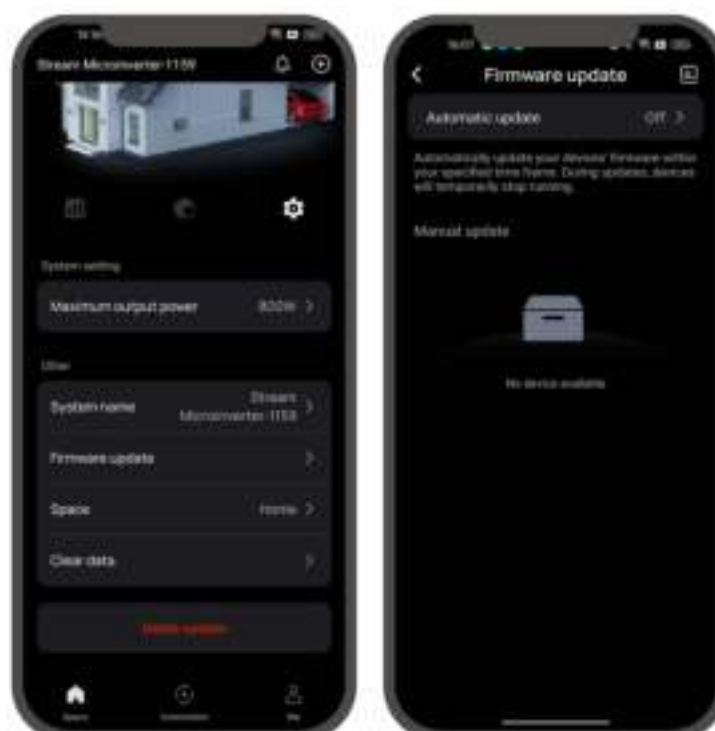

## Explore More

### Add EcoFlow STREAM AC Pro for Energy Storage

The EcoFlow STREAM Microinverter is designed to enhance functionality through integration with other STREAM products.

Connecting to an **EcoFlow STREAM AC Pro** adds home energy storage capabilities. By default, surplus solar energy is stored in the **AC Pro** and automatically discharged to meet connected load demands during periods of low solar generation. The AC Pro also supports grid charging during off-peak electricity pricing periods. The energy scheme can be flexibly adjusted via the EcoFlow app once the system is bound to your EcoFlow account.

- **To Connect to an EcoFlow STREAM AC Pro**

1. Connect the microinverter to an AC outlet of the AC Pro.
2. Connect the AC Pro's Grid terminal to your home outlet and secure the connection.
3. Press the **AC ON/OFF** button of the AC Pro once to enable the AC outlet.
4. Bind the microinverter and the AC Pro to your EcoFlow app, and ensure they are connected to the internet.

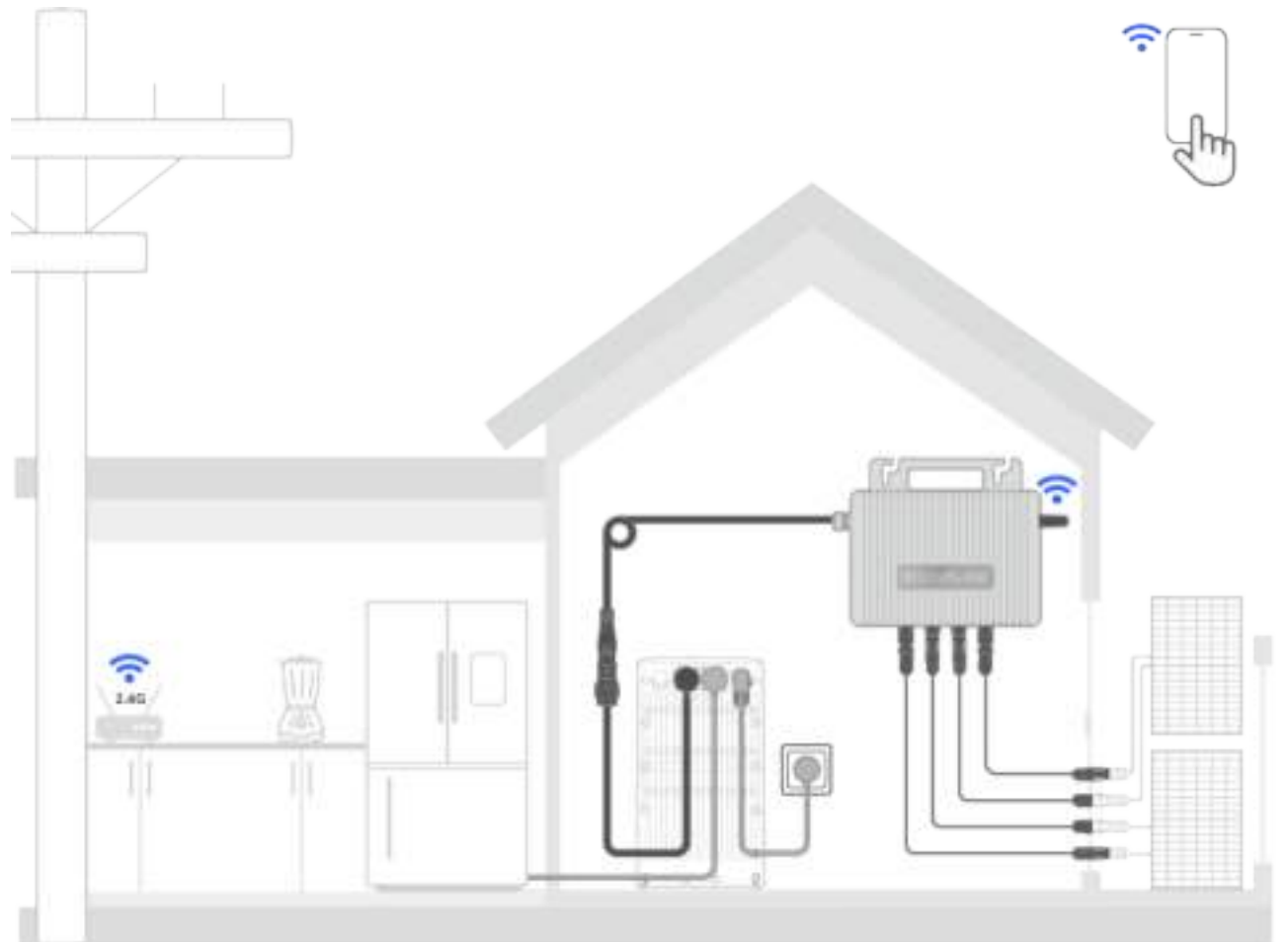

The grid connection must comply with local regulations and standards.



#### Recommended Cable

- For AC Connection: EcoFlow STREAM BKW AC Cable
- For Grid Connection: EcoFlow STREAM BKW AC Cable

## Add EcoFlow STREAM Ultra/Pro for Energy Storage and Extra Solar Input

The EcoFlow STREAM Microinverter is designed to enhance functionality through integration with other STREAM products.

Connecting to an **EcoFlow STREAM Ultra** or **EcoFlow STREAM Pro** adds home energy storage capabilities and allows for additional solar power input. By default, surplus solar energy is stored in the **Ultra/Pro** and automatically discharged to meet connected load demands during periods of low solar generation. The **Ultra/Pro** also supports grid charging during off-peak electricity pricing periods. The energy scheme can be flexibly adjusted via the EcoFlow app once the system is bound to your EcoFlow account.

- **To Connect to an EcoFlow STREAM Ultra /EcoFlow STREAM Pro**

1. Connect the microinverter to an AC outlet of the Ultra/Pro.
2. Connect the Ultra/Pro's Grid terminal to your home outlet and secure the

connection.

3. Press the **AC ON/OFF** button of the Ultra/Pro once to enable the AC outlet.
4. Bind the microinverter and the Ultra/Pro to your EcoFlow app, and ensure they are connected to the internet.

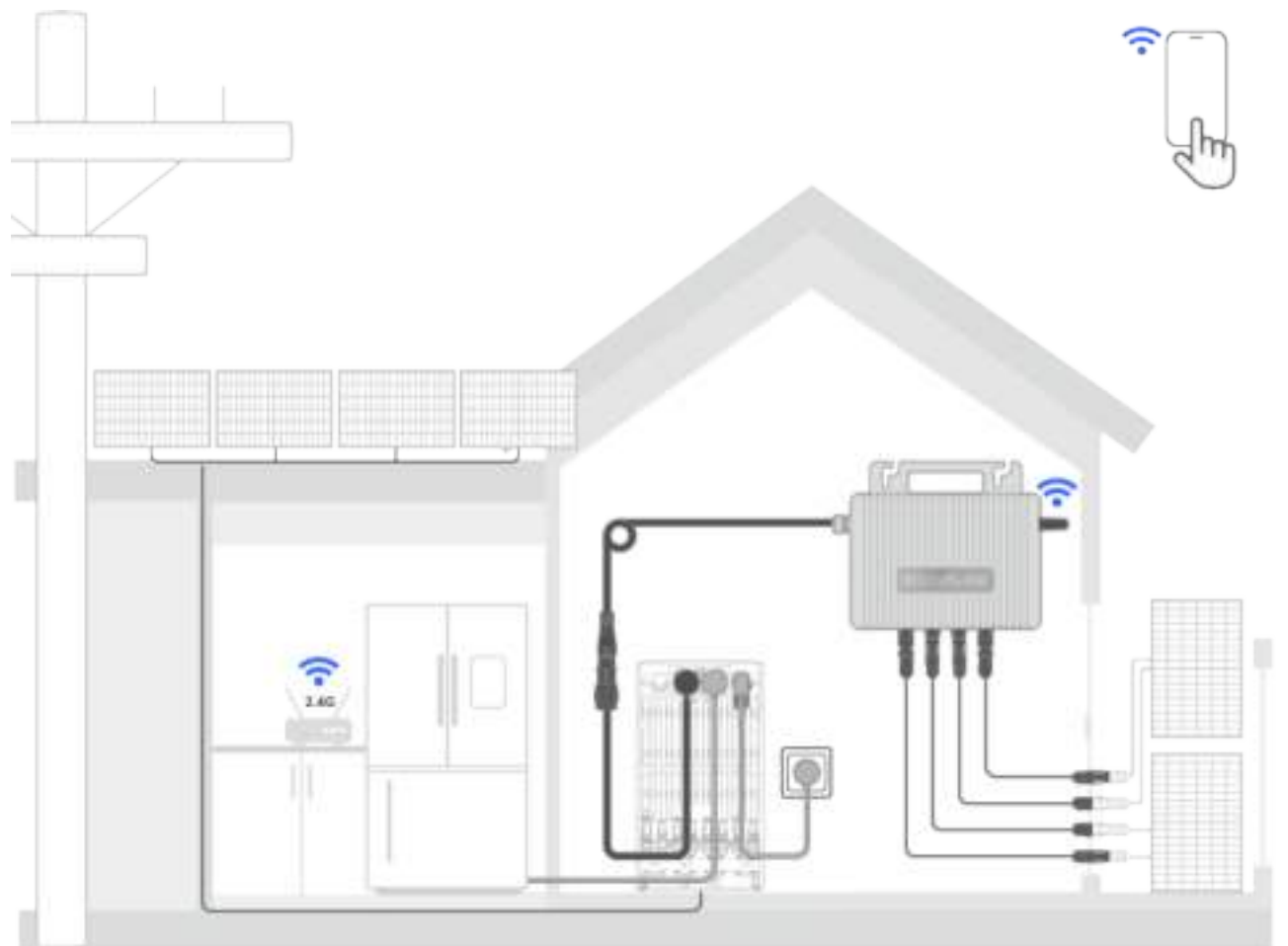

The grid connection must comply with local regulations and standards.



In this configuration, the total feed-in power is also limited by local regulations.

## Storage and Maintenance

### Routine Maintenance

For routine maintenance, follow these steps:

1. Use a soft, dry cloth to wipe the product shell and keep it clean.
2. Check if all the connection components are in good condition every 6 months.

### Product Removal

To remove the microinverter, carefully follow these steps:

1. **Disconnect Power:** Completely power off all connected devices and equipment. This includes turning off the circuit breaker at the electrical panel that supplies power to the microinverter.
2. **Disconnect Load Cable:** Disconnect the AC cable from the connected load (e.g., your home's electrical system).

3. **Disconnect PV Cables:** Disconnect the PV cables from the solar panels.
4. **Detach the Microinverter:** Unscrew the microinverter from the wall or solar panel mounting bracket. Support the microinverter to prevent dropping it during removal.
5. **(Optional) Disposal:** If the microinverter can not work anymore, dispose of it in accordance with the local disposal requirements for electrical equipment waste.

## Long-term Storage

For long-term storage, restore the microinverter to its original package in a dry and tidy place. Protect all components to prevent severe moisture, shocks, vibrations, and so on. The storage temperature of the microinverter should be maintained between  $-40^{\circ}\text{C}$  to  $+85^{\circ}\text{C}$ .

## Troubleshooting

The microinverter's LED provides a basic indicator to check the device's status. If you notice an abnormal LED pattern, refer to the in-app instructions for troubleshooting.



Flashing Red: The microinverter is faulty. Check the EcoFlow app for detailed instructions.



Solid Red: The microinverter is faulty. Open the EcoFlow app to access the device settings. If accessible, follow the in-app troubleshooting steps. If not, contact technical support.



If you cannot access the EcoFlow app, contact EcoFlow Customer Service for assistance. Do not attempt to repair this product without official instructions from the support team.

## Safety Instructions and Regulatory Compliance

### Disclaimer

Please read the product documentation thoroughly and ensure you understand it before using the product. Improper use may cause serious injury, product damage, or property loss. Always refer to the most up-to-date documentation

available at <https://www.ecoflow.com/support/download/>. This documentation takes precedence over all other versions.

By using this product, you acknowledge and agree to all terms and conditions stated in the documentation. EcoFlow is not liable for losses caused by improper use or failure to adhere to the provided instructions. Subject to applicable laws and regulations, EcoFlow reserves the right to the final interpretation of this document and all documents related to the product.

## Safety Symbols

The shell or nameplate of this product includes safety symbols to indicate potential hazards. Please review these signs and their meanings as detailed in the table below:

Note: "This product" or "the device" refers to the EcoFlow STREAM Microinverter throughout this document.



### Caution

Disconnect the device from all voltage sources before servicing.



### High Voltage

The high voltage generated by the device can endanger life.



### High Temperature

Do not touch the device shell, as it may become hot during operation.



### Reading Manual

Read the user manual and all safety instructions carefully before installation, operation, and maintenance.



### CE Marking

The device complies with the essential requirements of the relevant EU legislation.



### WEEE Directive

Do not dispose of the device as household waste. Follow local electronic waste disposal regulations.



### Grounding

Indicates the position for connecting the protective earthing (PE) cable.

## Safety Instructions

1. Read this instruction and other related product documents before any operation.
2. The electrical installation of this product must comply with local electrical regulations.
3. An overcurrent circuit breaker must be installed between this product and

the grid.

4. Understand the components and function of the grid-tied PV power system. Make sure that all electrical connections, voltage, and frequency at the connection point meet the local microinverter grid-tied requirements.
5. This product is designed for various scenarios. Certain installation or servicing tasks must be performed exclusively by a qualified technician. Refer to the personnel requirements highlighted in the product documentation to ensure these tasks are completed correctly and safely.
6. Use insulation tools and wear personal protective equipment when installing, servicing, or maintaining this product.
7. Keep this product out of reach of children and pets.
8. Install this product in a tidy, dry, and well-ventilated environment.
9. Do not expose this product to direct sunlight, rain, and snow.
10. Do not expose this product to strong electromagnetic fields to avoid radio interference.
11. Do not install or operate this product near flammable, explosive, corrosive, or caustic sources.
12. Do not install or operate this product during extreme weather events such as lightning, heavy rain, or strong wind.
13. Do not use any damaged cords or cables with this product.
14. Do not touch this product shell during operation, as it may become hot (up to 80°C).
15. Do not subject this product to severe impacts, vibrations, or drops to prevent physical damage.
16. Do not drag, squeeze, or step on this product, or throw it into the fire, as there is a risk of explosion.
17. Do not damage, deface, or remove any labels on this product.
18. Do not disassemble, repair, or modify this product by yourself. For any maintenance or service, contact EcoFlow Customer Service.
19. Do not use any unofficial or unrecommended components and accessories. For any replacements, please contact EcoFlow for further assistance.
20. Cable Connection: Ensure that any load to be connected (e.g., devices or equipment intended to be powered by this product) is powered off before making any electrical connections.
21. **Cable Removal:** To safely remove this product, perform the following steps in sequence:
  - De-energize the connected load.
  - Disconnect the cable from the connected load.
  - Disconnect all cables from this product.
22. **GROUNDING INSTRUCTIONS:** This product must be grounded. If it should malfunction or breakdown, grounding provides a path of least resistance for electric current to reduce the risk of electric shock. For your safety, EcoFlow provides a cord with an equipment grounding conductor/a grounding plug. The plug must be plugged into an outlet that is properly installed and grounded in accordance with all local codes and ordinances. **WARNING** – Improper connection of the equipment grounding conductor can result in a risk of electric shock. If you encounter the following situations, consult a qualified electrician instead of modifying the plug provided with the product:
  - You are unsure whether the product is properly grounded;
  - You find that the plug provided with the product does not fit the outlet.
23. **EXTERNAL GROUNDING INSTRUCTIONS:** Supplemental grounding may be

necessary at installation sites with inadequate grounding or specific grounding requirements mandated by local codes. In such cases, use the grounding terminal on this product to establish proper grounding.

24. Ensure that the cable length for each PV connection to this product is less than 3 meters.

## Regulatory Compliance



Hereby, EcoFlow Inc. declares that this product is in compliance with Directives 2014/35/EU, 2014/30/EU, 2014/53/EU, 2011/65/EU(RoHS), (EU) 2015/863(RoHS). The full text of the EU Declaration of Conformity is available at the following Internet addresses: <http://www.ecoflow.com/eu/eu-compliance>

### Radio Frequency (RF) Specifications for EU:

- Bluetooth:
  - Frequency: 2.400 GHz - 2.4835 GHz
  - Maximum Output Power: 9.89 dBm
- WLAN :
  - Frequency: 2.412 GHz - 2.472 GHz
  - Maximum Output Power: 18.36 dBm



This marking indicates that this product should not be disposed of with other household waste within the EU. Recycle this product properly to prevent possible damage to the environment or a risk to human health via uncontrolled waste disposal and in order to promote the sustainable reuse of material resources. Please return your used product to an appropriate collection point or contact the retailer where you purchased this product. Your retailer will accept used products and return them to an environmentally-sound recycling facility.

For information on the disposal of electrical and electronic equipment, please visit the following website:

<https://eu.ecoflow.com/pages/electronic-devices-disposal>



The Bluetooth® word mark and logos are registered trademarks owned by Bluetooth SIG, Inc. and any use of such marks by EcoFlow Inc. is under license. Other trademarks and trade names are those of their respective owners.

## Appendix

### Technical Specification

General Info	
Model	EF-PS-800, EF-PS-600
Dimensions	252 × 180 × 35 mm

Weight	3.2 kg
IP Rating	IP67
Pollution Degree	PD3
Cooling Method	Natural convection (no fans)

#### Input (DC)

Typical Module Compatibility	EF-PS-800: 320W-600W+ EF-PS-600: 200W-450W+
Number of Modules Connected	2
Number of MPPTs	2
Range of MPPT Voltage	16V-60V
Max. Input Voltage	65V
Start-up Input Voltage	20V
Max. Input Current	2 × 16A
Max. Input Short Circuit Current	2 × 20A
OVC Category	II

#### Output (AC)

Nominal Output Power	EF-PS-800: 800W EF-PS-600: 600W
Nominal Output Current	EF-PS-800: 3.48A EF-PS-600: 2.61A
Nominal Output Voltage	220V / 230V / 240V
Output Voltage Range	183V - 276V
Nominal Output Frequency	50Hz / 60Hz
Power Factor (adjustable)	>0.99 / 0.8 leading...0.8 lagging
Total Harmonic Distortion	< 3%
OVC Category	III
Protective Class	Class I

#### Efficiency

Nominal MPPT	99.80%
--------------	--------

## Efficiency

Night-time Power Loss < 60mW

## Environment

Operating Altitude ≤ 3000 m

Operating Ambient Temperature -40°C to 65°C

Relative Humidity 5%-95%

## Features

Communication WLAN, Bluetooth

Monitoring EcoFlow app

Type of Isolation Galvanically Isolated HF Transformer

Built-in Feature Output Overcurrent Protection, Output Overvoltage Protection, Anti-islanding Protection

## Compatibility List

### Cables and Accessories

- EcoFlow STREAM BKW-AC Cable
- EcoFlow STREAM BKW DIY Cable
- PV Clamp Holder

### Compatible Devices

- EcoFlow STREAM Ultra
- EcoFlow STREAM Pro
- EcoFlow STREAM AC Pro